

Instruction Manual

HI 8633 HI 8733 - HI 8734

**Reliable and Waterproof
Multi-Range
Conductivity Meters**

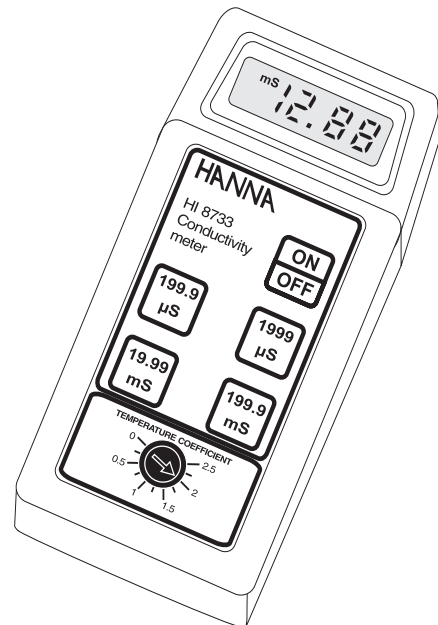

TABLE OF CONTENTS

PRELIMINARY EXAMINATION	3
GENERAL DESCRIPTION	3
FUNCTIONAL DESCRIPTION & SPECIFICATIONS OF HI 8633	4
FUNCTIONAL DESCRIPTION & SPECIFICATIONS OF HI 8733	5
FUNCTIONAL DESCRIPTION & SPECIFICATIONS OF HI 8734	6
OPERATIONAL GUIDE	7
CALIBRATION	8
CONDUCTIVITY VERSUS TEMPERATURE CHART	12
TDS VERSUS TEMPERATURE CHART	13
DETERMINING THE TEMPERATURE COEFFICIENT OF A SOLUTION (HI 8733)	14
PROBE MAINTENANCE	15
BATTERY REPLACEMENT	16
ACCESSORIES	17
WARRANTY	18
CE DECLARATION OF CONFORMITY	19

GENERAL DESCRIPTION

HI 8633 and HI 8733 have been designed specifically for use in the areas of production and quality control. It is often necessary to test samples with different concentrations ranging from deionized water to brine.

Both models can be manually calibrated at 1 point.

The HI 8733, with a built-in temperature sensor and Automatic Temperature Compensation, is the perfect instrument for measuring samples with fluctuating temperature.

HI 8734 has been specially designed for the water conditioning industry, particularly in the softening, demineralization, reverse osmosis and drinking water applications.

Three ranges of measurement assure the highest accuracy possible. In addition, Manual Temperature Compensation is possible through a knob on the front panel.

The ratio between conductivity and TDS is factory set at 0.5.

Moreover, the 4-ring potentiometric probes supplied with the meters are made of rugged PVC - ideal for indoor, as well as outdoor measurements.

FUNCTIONAL DESCRIPTION & SPECIFICATIONS OF HI 8633

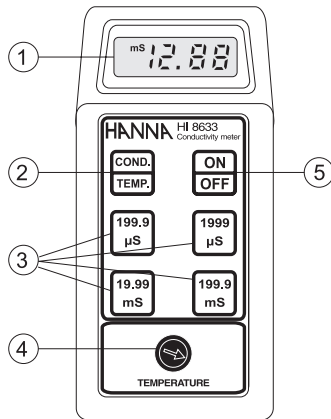

- 1) Liquid Crystal Display
- 2) Conductivity/temperature selection key
- 3) Measurement range selection keys
- 4) Manual temperature compensation knob
- 5) ON/OFF key

Range	0.0 to 199.9 / 0 to 1999 $\mu\text{S}/\text{cm}$ 0.00 to 19.99 / 0.0 to 199.9 mS/cm
Resolution	0.1 / 1 $\mu\text{S}/\text{cm}$ 0.01 / 0.1 mS/cm
Accuracy (@ 20°C/68°F)	$\pm 1\%$ Full Scale excluding probe error
Typical EMC Deviation	$\pm 2\%$ Full Scale
Calibration	Manual, 1 point, through trimmer
Temperature Compensation	Manual, 0 to 50°C (32 to 122°F) with $\beta = 2\%/^{\circ}\text{C}$
Probe (included)	HI 76301D with 1m (3.3') cable
Environment	0 to 50°C (32 to 122°F); RH max 100%
Battery Type Life	1 x 9V, alkaline (IEC 6LR61) Approx. 100 hours of continuous use
Dimensions	164 x 76 x 45 mm (6.5 x 3.0 x 1.8")
Weight	250 g (8.8 oz.)

FUNCTIONAL DESCRIPTION & SPECIFICATIONS OF HI 8733

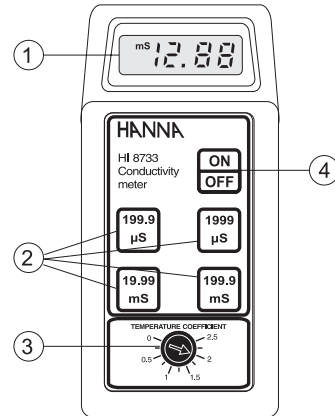

- 1) Liquid Crystal Display
- 2) Measurement range selection keys
- 3) Automatic Temperature Compensation coefficient knob
- 4) ON/OFF key

Range	0.0 to 199.9 / 0 to 1999 $\mu\text{S}/\text{cm}$ 0.00 to 19.99 / 0.0 to 199.9 mS/cm
Resolution	0.1 / 1 $\mu\text{S}/\text{cm}$ 0.01 / 0.1 mS/cm
Accuracy (@ 20°C / 68°F)	$\pm 1\%$ Full Scale excluding probe error
Typical EMC Deviation	$\pm 2\%$ Full Scale
Calibration	Manual, 1 point, through trimmer
Temperature Compensation	Automatic, 0 to 50°C (32 to 122°F) with β adjustable from 0 to 2.5% per $^{\circ}\text{C}$
Probe (included)	HI 76302W ATC with 1m (3.3') cable
Environment	0 to 50°C (32 to 122°F); RH max 100%
Battery Type Life	1 x 9V, alkaline (IEC 6LR61) Approx. 100 hours of continuous use
Dimensions	164 x 76 x 45 mm (6.5 x 3.0 x 1.8")
Weight	250 g (8.8 oz.)

FUNCTIONAL DESCRIPTION & SPECIFICATIONS OF HI 8734

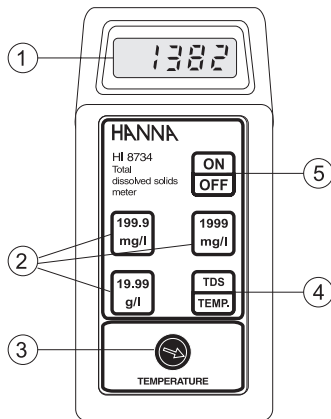

- 1) Liquid Crystal Display
- 2) Measurement range selection keys
- 3) Manual temperature compensation knob
- 4) TDS/temperature selection key
- 5) ON/OFF key

Range	0.0 to 199.9 / 0 to 1999 mg/L 0.00 to 19.99 g/L
Resolution	0.1 / 1 mg/L 0.01 g/L
Accuracy (@ 20°C / 68°F)	±1% Full Scale excluding probe error
Typical EMC Deviation	±2 % Full Scale
Calibration	Manual, 1 point, through trimmer
Temperature Compensation	Manual, 0 to 50°C (32 to 122°F) with $\beta = 2\%/^{\circ}\text{C}$
TDS factor	0.5
Probe (included)	HI 76301D with 1m (3.3') cable
Environment	0 to 50°C (32 to 122°F); RH max 100%
Battery Type Life	1 x 9V, alkaline (IEC 6LR61) Approx. 100 hours of continuous use
Dimensions	164 x 76 x 45 mm (6.5 x 3.0 x 1.8")
Weight	250 g (8.8 oz.)

OPERATIONAL GUIDE

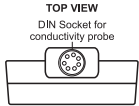
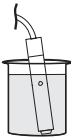
- Each meter is supplied complete with a 9V battery. Remove the battery compartment cover on the back of the meter (see page 16). Install the battery while paying attention to its polarity.
- Connect the probe to the meter securely by aligning the pins with the socket and pushing the plug in. 
- Make sure that the meter has been calibrated before taking any measurements (see "Calibration" section).
- Immerse the conductivity probe into the sample, with the holes on the shaft completely submerged.  If possible, use plastic beakers or containers to minimize any EMC interference.
- Tap the probe lightly on the bottom of the beaker to remove any air bubbles which may be trapped inside the PVC sleeve.
- Turn the instrument on by pressing the ON/OFF key.

For HI 8633 and HI 8734:

Take the temperature of the solution with a ChecktempC or another accurate thermometer. 

Press the COND/TEMP key for HI 8633 or TDS/TEMP for HI 8734 to display the temperature and adjust the temperature knob to that of the solution e.g. 20°C.

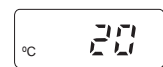
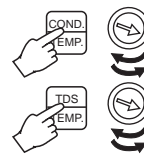

For HI 8733:

Adjust the TEMPERATURE COEFFICIENT knob to 2% to compensate for the temperature effect of average solutions (to determine exact value for a particular solution, see page 14).

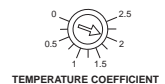

- Select the appropriate measurement range.

Note: If the display shows only a "1" on the far left hand side, the meter is out of range. Select the next (higher) range.



- Wait for a couple of minutes for the temperature sensor to reach thermal equilibrium with the sample before taking measurements.
- After the measurement has been completed, the instrument should be switched off and the probe should be cleaned and dried (see "Probe Maintenance" on page 15).

CALIBRATION

Accessories needed:

- Use any calibration solution within the meter's range. The solution should ideally be close to the samples being measured. Use for example **HI 7030** or **HI 8030**, 12880 $\mu\text{S}/\text{cm}$ ($=12.88 \text{ mS}/\text{cm}$) conductivity solution, for **HI 8633** and **HI 8733**, and **HI 7032**, 1382 mg/L ($=2764 \mu\text{S}/\text{cm}$) TDS solution, for **HI 8734**.
- ChecktempC or another accurate thermometer with 0.1°C resolution (not necessary for **HI 8733**).
- a small screwdriver.

PROCEDURE FOR HI 8633 AND HI 8734

- Pour sufficient quantity of a conductivity (HI 8633) or TDS (HI 8734) calibration solution (e.g. HI 7030 or HI 7032) into a beaker to cover the holes on the probe. If possible, use plastic beakers to minimize any EMC interference.
- Immerse the conductivity probe, making sure that holes are completely submerged, and the ChecktempC in the solution.
- Wait for a couple of minutes for thermal equilibrium to be reached.
- Tap the probe on the bottom, then shake it while rotating to make sure no



8

air bubbles remain trapped in the sleeve.

- Record the temperature of the buffer solution from the thermometer (e.g. 18°C).
- Switch the instrument on by pressing ON/OFF.



- Press COND/TEMP (HI 8633) or TDS/TEMP (HI 8734) to display the temperature.



- Adjust the TEMPERATURE knob to display 18°C.

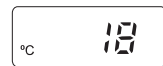

- Press COND/TEMP (or TDS/TEMP) again to display conductivity measurement.



- Select 19.99 mS/cm (HI 8633) or 1999 mg/L (HI 8734) range by pressing the appropriate range key.



- Remove the battery compartment cover and adjust the calibration trimmer located inside with the calibration screwdriver until the display shows for **HI 8633** the conductivity reading at 25°C (see the conductivity vs. temperature table), e.g. @ 25°C, 12880 $\mu\text{S}/\text{cm} = 12.88 \text{ mS}/\text{cm}$, or for **HI 8734** the TDS reading at 25°C (see the TDS vs. temperature chart), e.g. @25°C, 1382 mg/L .

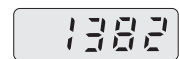
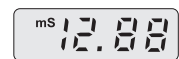
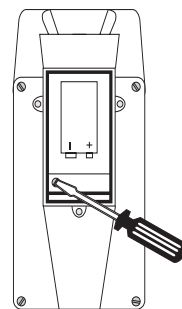

9

- All subsequent measurements will be compensated to 25°C (77°F). If you prefer to standardize the temperature compensation to 20°C (68°F) rather than 25°C (77°F), leave the TEMPERATURE knob at 18°C (if the temperature of the solution is 18°C), adjust the trimmer to read "11.67 mS" (see the conductivity vs. temperature chart) or "1251 mg/L" (see the TDS vs. temperature chart). All subsequent measurements will be compensated to 20°C.
- The calibration is now complete and the instrument is ready for use.

The instrument should be recalibrated at least once a month, or when the probe is changed.

Note: For more accurate results, it is advisable to use a calibration solution close to the measurement range. See the "Accessories" section for a wide selection of conductivity solutions.

PROCEDURE FOR HI 8733

- Pour sufficient quantity of a conductivity calibration solution (e.g. HI 7030/ HI 8030) into a beaker to cover the holes on the probe. If possible, use plastic beakers to minimize any EMC interference.
- Immerse the conductivity probe in the solution, making sure that holes are completely submerged.
- Wait for a couple of minutes for thermal equilibrium to be reached.
- Tap the probe on the bottom, then shake it while rotating to make sure no air bubbles remain trapped in the sleeve.
- Switch the instrument on by pressing ON/OFF.
- Set the temperature coefficient knob to 2% to compensate for the temperature effect of average solutions (to determine exact value for a particular solution, see page 14).
- Select 19.99 mS/cm range by pressing the appropriate range key.

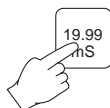
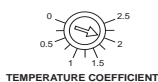

- Remove the battery compartment cover and adjust the calibration trimmer located inside with the calibration screwdriver until the display shows "12.88 mS" i.e. the conductivity reading @ 25°C.

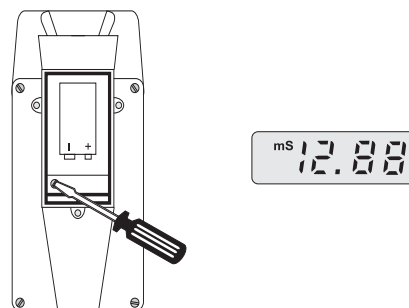

- All subsequent measurements will be compensated to 25°C (77°F). If you prefer to standardize the temperature compensation to 20°C (68°F) rather than 25°C (77°F), adjust the trimmer to read "11.67 mS" (see the conductivity vs. temperature chart on page 18). All subsequent measurements will be compensated to 20°C.
- The calibration is now complete and the instrument is ready for use.

The instrument should be recalibrated at least once a month, or when the probe is changed.

Note: For more accurate results, it is advisable to use a calibration solution close to the range to be measured. See the "Accessories" section for a wide selection of conductivity solutions.

CONDUCTIVITY VERSUS TEMPERATURE CHART

The conductivity of an aqueous solution is the measure of its ability to carry an electrical current by means of ionic motion.

The conductivity invariably increases with increasing temperature.

It is affected by the type and number of ions in the solution and by the viscosity of the solution itself. Both parameters are temperature dependent. The dependency of conductivity on temperature is expressed as a relative change per degree Celsius at a particular temperature, commonly as percent per °C.

For manual temperature compensation, refer to the following chart:

°C	°F	HI 7030 HI 8030 ($\mu\text{S/cm}$)	HI 7031 HI 8031 ($\mu\text{S/cm}$)	HI 7033 HI 8033 ($\mu\text{S/cm}$)	HI 7034 HI 8034 ($\mu\text{S/cm}$)	HI 7035 HI 8035 ($\mu\text{S/cm}$)	HI 7039 HI 8039 ($\mu\text{S/cm}$)
0	32	7150	776	64	48300	65400	2760
5	41	8220	896	65	53500	74100	3180
10	50	9330	1020	67	59600	83200	3615
15	59	10480	1147	68	65400	92500	4063
16	60.8	10720	1173	70	67200	94400	4155
17	62.6	10950	1199	71	68500	96300	4245
18	64.4	11190	1225	73	69800	98200	4337
19	66.2	11430	1251	74	71300	100200	4429
20	68	11670	1278	76	72400	102100	4523
21	69.8	11910	1305	78	74000	104000	4617
22	71.6	12150	1332	79	75200	105900	4711
23	73.4	12390	1359	81	76500	107900	4805
24	75.2	12640	1386	82	78300	109800	4902
25	77	12880	1413	84	80000	111800	5000
26	78.8	13130	1440	86	81300	113800	5096
27	80.6	13370	1467	87	83000	115700	5190
28	82.4	13620	1494	89	84900	117700	5286
29	84.2	13870	1521	90	86300	119700	5383
30	86	14120	1548	92	88200	121800	5479
31	87.8	14370	1575	94	90000	123900	5575

For instance, the conductivity values of the calibration solutions at 25°C are 12880 $\mu\text{S/cm}$, 1413 $\mu\text{S/cm}$ or 5000 $\mu\text{S/cm}$ when using **HI 7030**, **HI 7031** or **HI 7039**, respectively.

At 20°C, the values are 11670 $\mu\text{S/cm}$, 1278 $\mu\text{S/cm}$ or 4523 $\mu\text{S/cm}$, respectively.

With the solutions at 30°C, the values are 14120 $\mu\text{S/cm}$, 1548 $\mu\text{S/cm}$ or 5479 $\mu\text{S/cm}$, respectively.

TDS VERSUS TEMPERATURE CHART

The TDS value in aqueous solutions is directly proportional to conductivity. The ratio between the two parameters depends on the solution and usually it is set to a factor of 0.5 (corresponding to a solution of CaCO_3). This means that 1 $\mu\text{S/cm}$ is equal to 0.5 mg/L (ppm) of TDS.

For manual temperature compensation, refer to the following chart:

°C	°F	HI 7032 mg/L (ppm)	HI 7036 g/L (ppt)
0	32	758	6.82
5	41	876	7.88
10	50	999	8.99
15	59	1122	10.10
16	60.8	1148	10.33
17	62.6	1173	10.56
18	64.4	1200	10.78
19	66.2	1224	11.01
20	68	1251	11.24
21	69.8	1277	11.47
22	71.6	1303	11.71
23	73.4	1329	11.94
24	75.2	1358	12.18
25	77	1382	12.41
26	78.8	1408	12.65
27	80.6	1438	12.89
28	82.4	1461	13.13
29	84.2	1476	13.37
30	86	1515	13.61
31	87.8	1541	13.85

For instance, the TDS values of the calibration solutions at 25°C are 1382 mg/L or 12.41 g/L when using **HI 7032** or **HI 7036**, respectively.

At 20°C, the values are 1251 mg/L or 11.24 g/L, respectively.

With the solutions at 30°C, the values are 1515 mg/L or 13.61 g/L, respectively.

DETERMINING THE TEMPERATURE COEFFICIENT OF A SOLUTION (HI 8733)

Highly acidic, alkaline samples or solutions with high salt content might have a different coefficient than the customary 2% per degree °C. In order to calculate this coefficient follow the procedure below:

- Immerse the probe of **HI 8733** in the sample and adjust the TEMPERATURE COEFFICIENT knob to 0% (i.e. no compensation).



- Condition the sample and probe to 25°C and note the conductivity reading, C_{25} .
- Condition the sample and probe to a different temperature $t^{\circ}\text{C}$ (approximately 10°C different from 25°C) and note the conductivity reading C_t .
- The temperature coefficient β of the solution is calculated as given by the following formula:

$$\beta = 100 \times \frac{(C_t - C_{25})}{(t - 25) \times C_{25}}$$

The above procedure is suitable for determining the temperature coefficient in a laboratory or where the temperature of the solution can be controlled.

If this is not possible (e.g. on-site measurements), the following procedure can be used providing the sample temperature varies by at least 5°C or preferably 10°C:

- Immerse the probe of **HI 8733** in the test solution and turn the TEMPERATURE COEFFICIENT knob to 0% (no compensation).
- Check the conductivity reading and record the value. Make sure the reading is stable, i.e. no greater variations than ± 0.2 mS/cm within a minute.
- Repeat the procedure when the temperature of the test solution has changed by at least 5°C. Wait for the conductivity reading to stabilize.
- Adjust the TEMPERATURE COEFFICIENT knob until the display shows the same value as recorded earlier.
- The value indicated by the knob is the temperature coefficient of the solution.

PROBE MAINTENANCE

Rinse the probe with tap water after every series of measurements. If a more thorough cleaning is required, remove the PVC sleeve and clean the probe with a cloth or a nonabrasive detergent. When reinserting the sleeve onto the probe, be sure that the sleeve is in the right direction with the four holes towards the cable end.

After cleaning the probe, recalibrate the instrument.

The probe body is in PVC. For this reason it must never come into close contact with a heat source. If the probe is exposed to high temperatures (above 50°C/122°F), the rings might become loose or detached, resulting in a serious impairment of the probe. In such cases, the probe has to be replaced.

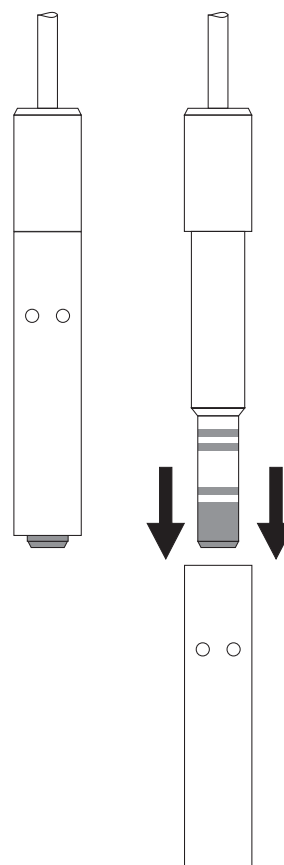

BATTERY REPLACEMENT

When the battery becomes weak the meters will display an additional blinking decimal point.

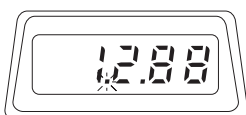

When the low battery indicator appears, the battery has only a few hours left. A low battery will result in unreliable measurements.

It is recommended to replace the battery immediately.

Battery replacement must only take place in a nonhazardous area using a 9V alkaline battery.

Unscrew the three screws on the rear of the meter, remove the battery compartment cover and replace the 9V battery with a new one.

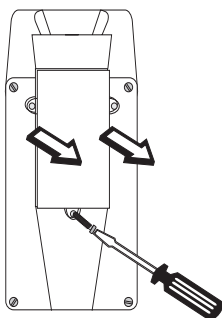

Make sure the battery contacts are tight and secure before replacing the cover.

ACCESSORIES

CALIBRATION SOLUTIONS

HI 7030L	12880 $\mu\text{S}/\text{cm}$, 500 mL bottle
HI 7030M	12880 $\mu\text{S}/\text{cm}$, 230 mL bottle
HI 7031L	1413 $\mu\text{S}/\text{cm}$, 500 mL bottle
HI 7031M	1413 $\mu\text{S}/\text{cm}$, 230 mL bottle
HI 7033L	84 $\mu\text{S}/\text{cm}$, 500 mL bottle
HI 7033M	84 $\mu\text{S}/\text{cm}$, 230 mL bottle
HI 7034L	80000 $\mu\text{S}/\text{cm}$, 500 mL bottle
HI 7034M	80000 $\mu\text{S}/\text{cm}$, 230 mL bottle
HI 7035L	111800 $\mu\text{S}/\text{cm}$, 500 mL bottle
HI 7035M	111800 $\mu\text{S}/\text{cm}$, 230 mL bottle
HI 7039L	5000 $\mu\text{S}/\text{cm}$, 500 mL bottle
HI 7039M	5000 $\mu\text{S}/\text{cm}$, 230 mL bottle
HI 7032L	1382 ppm (mg/L), 500 mL bottle
HI 7032M	1382 ppm (mg/L), 230 mL bottle
HI 7036L	12.41 ppt (g/L), 500 mL bottle
HI 7036M	12.41 ppt (g/L), 230 mL bottle

CONDUCTIVITY PROBES

HI 76301D	Conductivity probe with 1m (3.3') cable and DIN connector
HI 76302W	Conductivity probe with built-in temperature sensor, 1m (3.3') cable and DIN connector

OTHER ACCESSORIES

<i>ChecktempC</i>	Electronic thermometer (range: -50.0 to 150.0°C)
HI 710015	Shockproof rubber boot, blue
HI 710016	Shockproof rubber boot, orange
HI 710022	Spare protective case

WARRANTY

All Hanna Instruments meters are warranted for two years against defects in workmanship and materials when used for their intended purpose and maintained according to instructions. The probes are warranted for a period of six months. This warranty is limited to repair or replacement free of charge.

Damages due to accident, misuse, tampering or lack of prescribed maintenance are not covered.

If service is required, contact the dealer from whom you purchased the instrument. If under warranty, report the model number, date of purchase, serial number and the nature of the failure. If the repair is not covered by the warranty, you will be notified of the charges incurred. If the instrument is to be returned to Hanna Instruments, first obtain a Returned Goods Authorization number from the Customer Service department and then send it with shipping costs prepaid. When shipping any instrument, make sure it is properly packaged for complete protection.

All rights are reserved. Reproduction in whole or in part is prohibited without the written consent of the copyright owner.

Hanna Instruments reserves the right to modify the design, construction and appearance of its products without advance notice.

CE DECLARATION OF CONFORMITY



DECLARATION OF CONFORMITY

We

Hanna Instruments Italia Srl
via E.Fermi, 10
35030 Sarmeola di Rubano - PD
ITALY

herewith certify that the Conductivity meters:

HI 8633, HI 8733, HI 8734

have been tested and found to be in compliance with EMC Directive 89/336/EEC and Low Voltage Directive 73/23/EEC according to the following applicable normatives:

EN 50082-1: Electromagnetic Compatibility - Generic Immunity Standard
IEC 61000-4-2 Electrostatic Discharge
IEC 61000-4-3 RF Radiated

EN 50081-1: Electromagnetic Compatibility - Generic Emission Standard
EN 55022 Radiated, Class B

EN61010-1: Safety requirements for electrical equipment for measurement, control and laboratory use

Date of Issue: 17/12/2001

A. Marsilio - Technical Director
On behalf of
Hanna Instruments S.r.l.

Recommendations for Users

Before using these products, make sure that they are entirely suitable for the environment in which they are used. Operation of these instruments in residential area could cause unacceptable interference to radio and TV equipment, requiring the operator to take all necessary steps to correct interferences.

The metal band at the end of the probe is sensitive to electrostatic discharges. Avoid touching this metal band at all times.

Any variation introduced by the user to the supplied equipment may degrade the instruments' EMC performance. To avoid electrical shock, do not use these instruments when voltages at the measurement surface exceed 24 Vac or 60 Vdc.

Use plastic beakers to minimize any EMC interferences. To avoid damage or burns, do not perform any measurement in microwave ovens.



Thank you for reading this data sheet.

Please contact us for a quotation:



Head Office (UK)

P.O. Box 2124
Chelmsford
Essex CM1 3UP
England

Tel: +44 (0)1245 600 560
Fax: +44 (0)1245 600 030

Email:

General Information/Sales:
info@keison.com

Accounts Department:
accounts@keison.com



Switzerland Office

Zugerstrasse 46
6314 Unterägeri
Zug
Switzerland

Tel: +41 41 541 5877
Fax: +41 41 541 5878

Email:

General Information/Sales:
info@kesn.ch

Accounts Department:
accounts@kesn.ch



USA Office

233 Rogue River Highway #425
Grants Pass
Oregon 97527-5429
USA

Tel: +1 503 206 0941
Fax: +1 541 610 1646

Email:

General Information/Sales:
info@keison.com

Accounts Department:
accounts@keison.com



Latin America Office

World Trade Centre
Apartado 0832-00708
Ciudad de Panamá
República de Panamá

Tel: +507 836 5304
Fax: +507 399 1804

Email:

General Information/Sales:
ventas@keison.com

Accounts Department:
cuentas@keison.com